

Connector PowerTOP Xtra

Part Number: 14501



MENNEKES

Elektrotechnik GmbH & Co. KG
Aloys-Mennekes-Straße 1
57399 KIRCHHUNDEM GERMANY
www.MENNEKES.org

Product Description

- screw connection technology ErgoCONTACT
- X-CONTACT
- ergonomic enclosure design with nubbed grip zones
- rubberised cable gland with sealing
- strain relief and protection against kinking
- thread lock and safety slide
- area for self-adhesive labels

Technical Details

Connector - PowerTOP Xtra	14501
Product series	PowerTOP Xtra
Ampere	16 A
UL-Ampere	-
Number of Poles	3 P
Clock position	4 h
Voltage	110 V
Hertz	50-60 Hz
Current Type	AC
Protection Type	IP54
Contact carrier	X-CONTACT®
Pilot contact	Without pilot contact
Connection	Screw terminals - ErgoCONTACT®
Screw drive contact screw	Combination head screw (PZ2 and slotted)
Conductor cross-section min.	1 mm ²
Conductor cross-section max.	2.5 mm ²

Cable kink protection	Integrated in cable gland
Protective grommet	Without protective grommet
EAN / Identification number	4015394305491

Permissible ambient conditions

Permanent ambient temperature min. - max.	-25 °C - +40 °C
---	-----------------

Material properties

Hinged lid	PC similar RAL 1021 yellow
Cover	PA6 similar RAL 7000 grey
Front part	PA6 similar RAL 1021 yellow

Material resistance

The material resistance overview can be found on the website in the section “Knowledge” → “Product knowledge” → “Materials”

Regulations and Standards

REACH (Regulation (EG) No. 1907/2006)	Information according to article 33 REACH: SVHC: Lead (CAS: 7439-92-1)
RoHS 2011/65/EU incl. 2015/863/EU	✓
POP Regulation (EU) 2019/1021	✓
Norm(s)	IEC 60309-2
Declaration of conformity	CE

Dimensional drawing

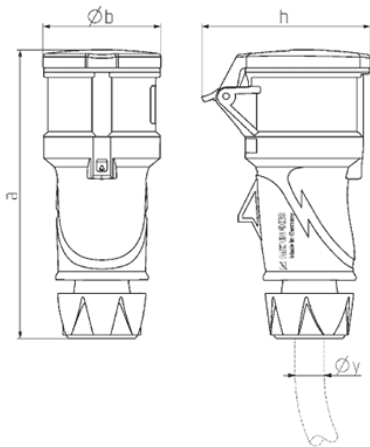

Drawing	Amp. Poles	16			32		
		3	4	5	3	4	5
3 MB 79							
Dim. in mm	a	165	177	174	211	211	209
	b	55	68	69	78	78	80
	h	72	93	98	100	100	108
y min. from		7	8	8	10.5	10.5	13.5
to max. mm		-13	-15.5	-15.5	-18	-18	-20
Terminal for cond. cross		1	1	1	2.5	2.5	2.5
section (mm²) min.-max.		-2.5	-2.5	-2.5	-6	-6	-6